

RTC-303

aro fixo periférico

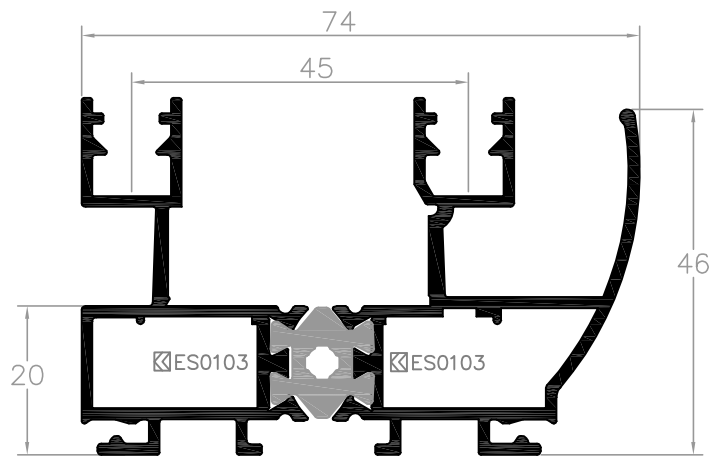

RTC-302

aro fixo periférico

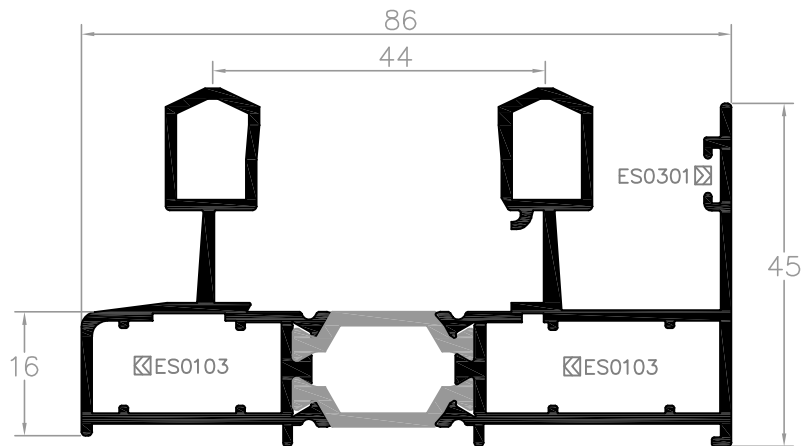

RTC-301

aro fixo periférico

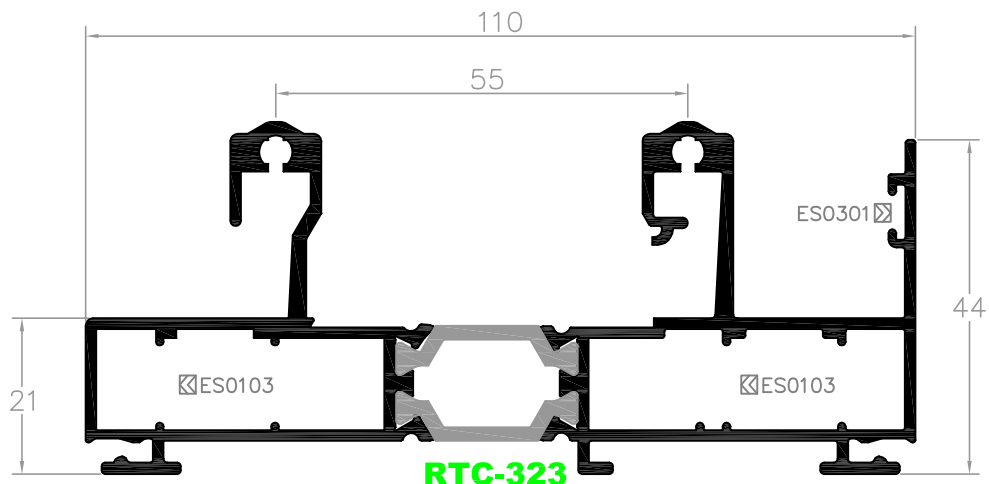

RTC-323

aro fixo periférico

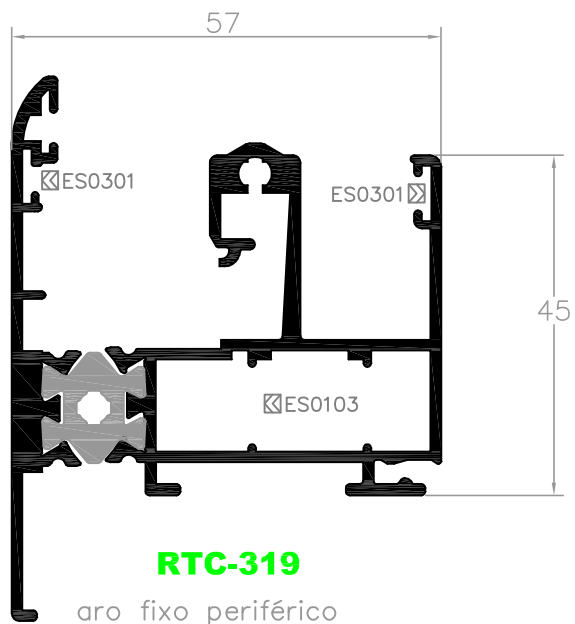

RTC-319

aro fixo periférico

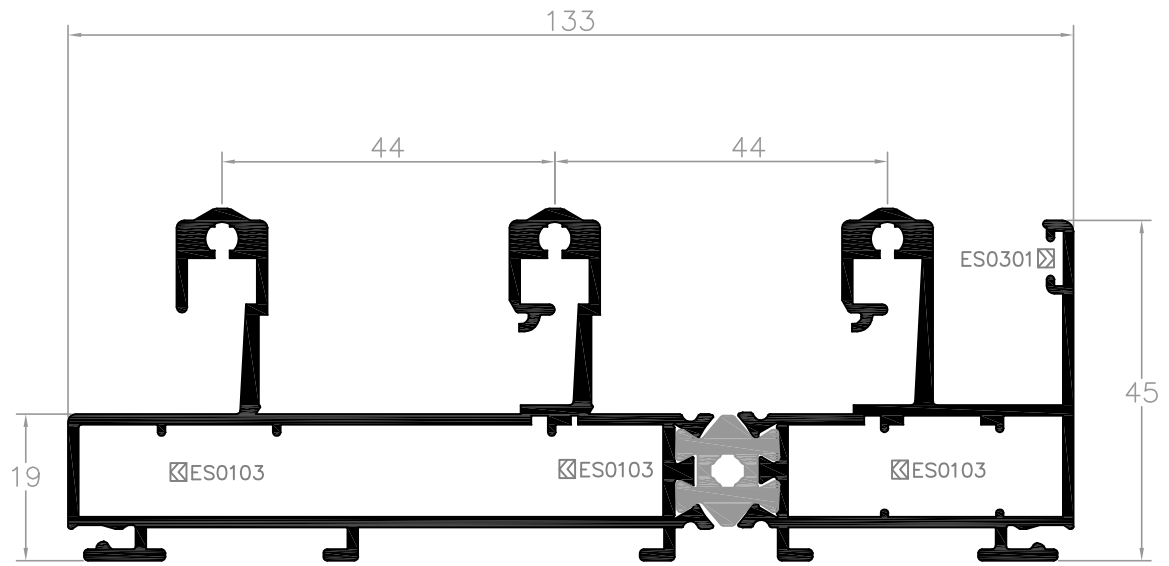

RTC-308

aro fixo periférico tri-raíl

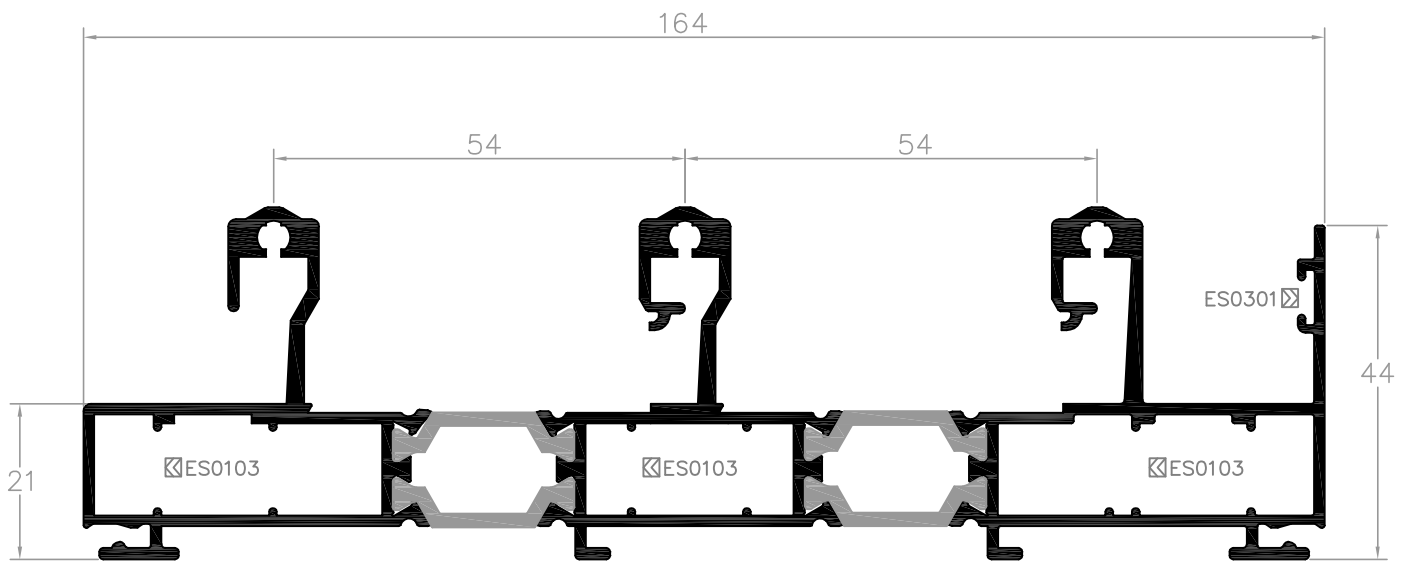

RTC-328

aro fixo periférico tri-raíl

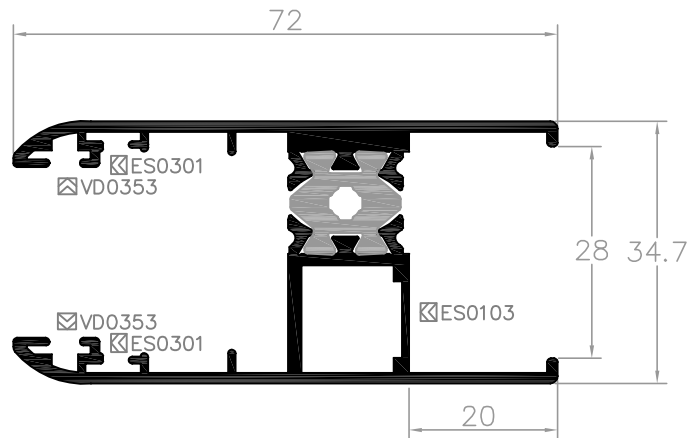

RTC-305

folha móvel periférica

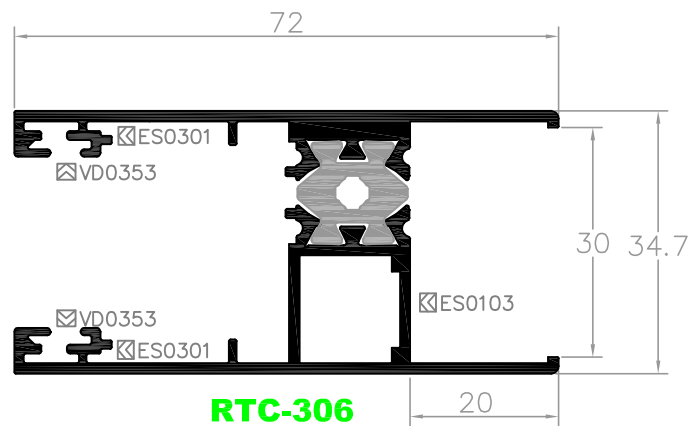

RTC-306

folha móvel periférica

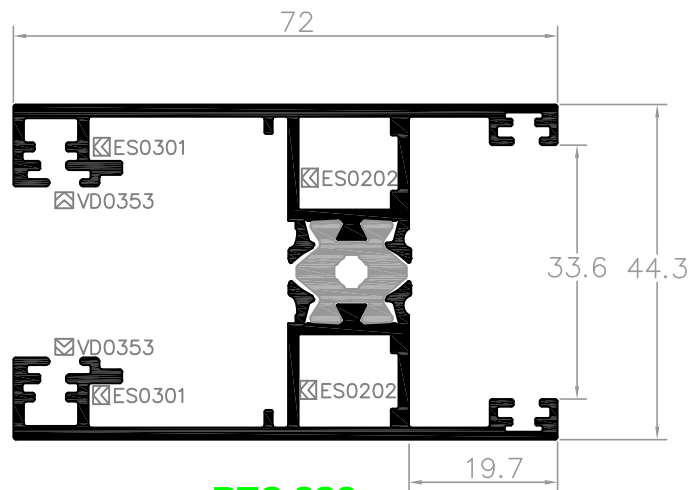

RTC-326

folha móvel periférica

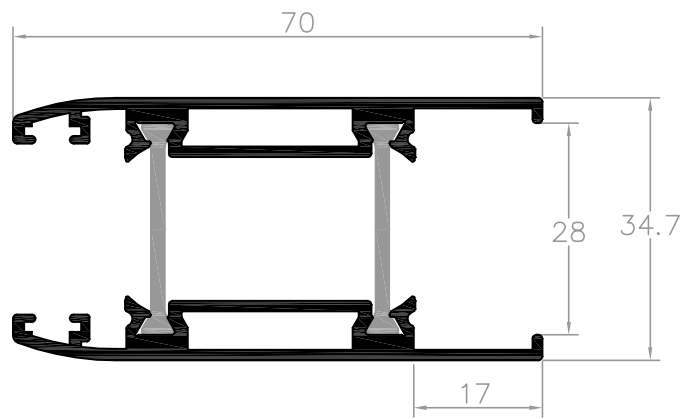

RTC-310

lateral móvel topo/topo

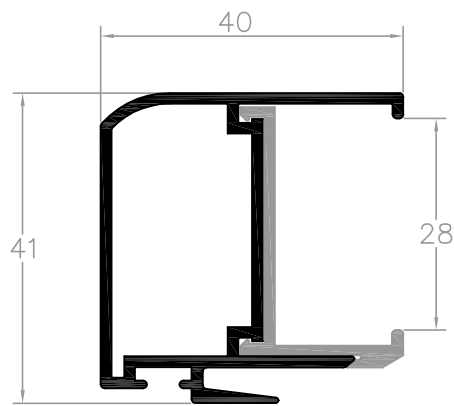

RTC-311

central móvel topo/topo

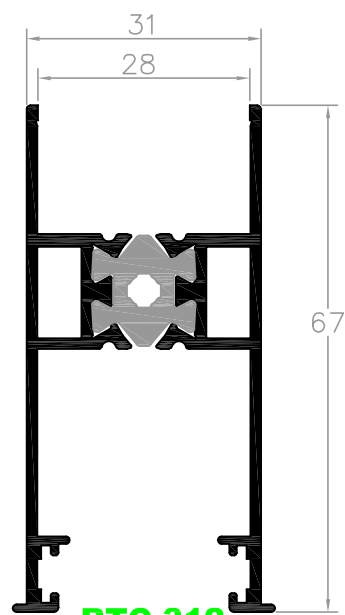

RTC-312

travessa superior/inferior

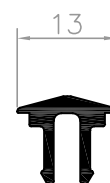
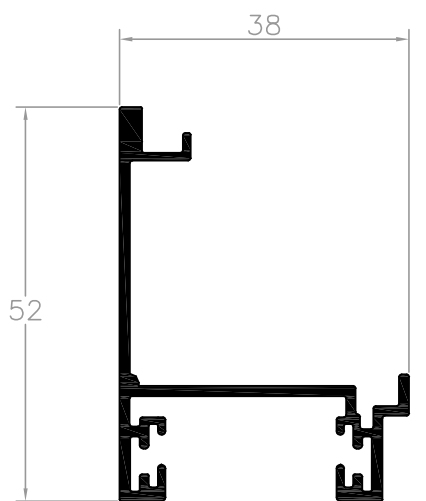
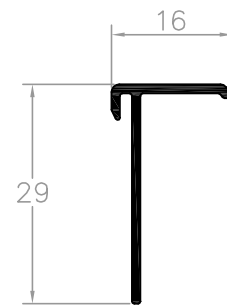
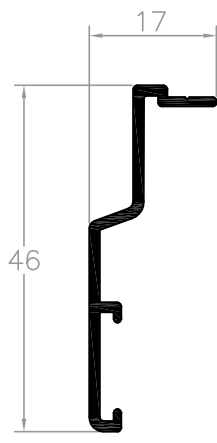
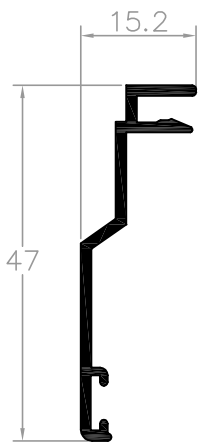
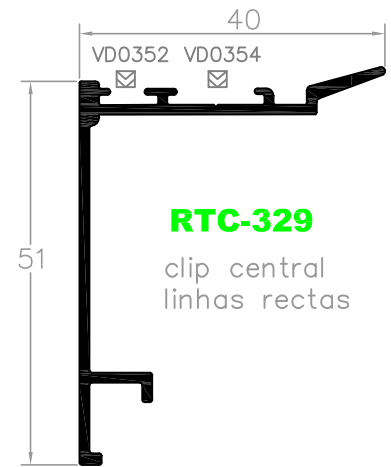
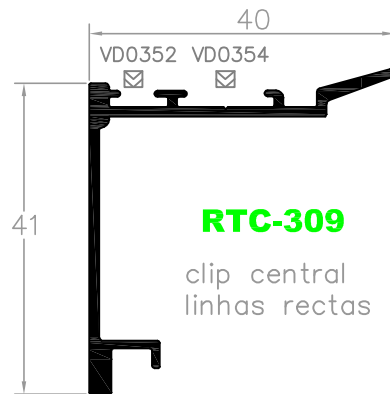
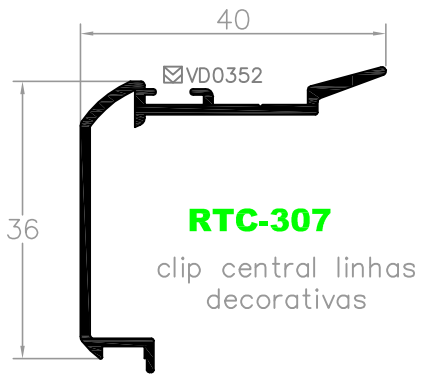

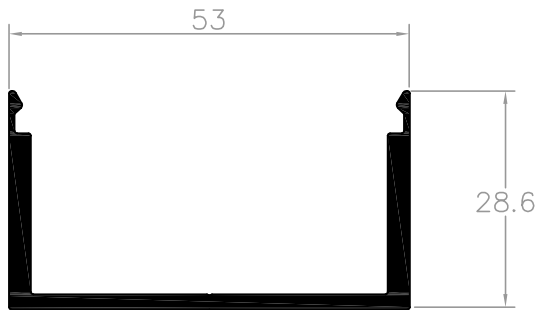

RTC-313

reforço

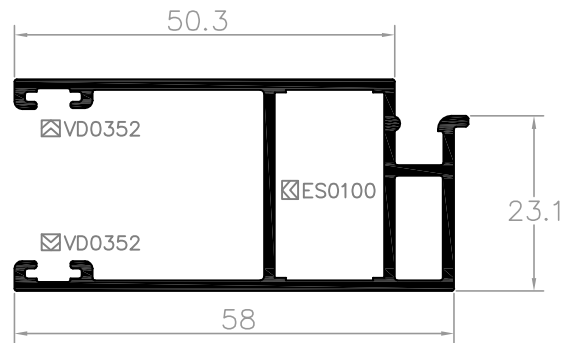

RTC-315

folha periférica
mosquiteira

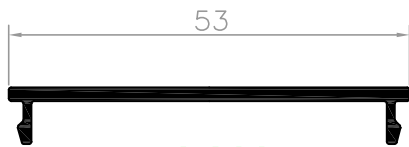

RTC-314

clip reforço

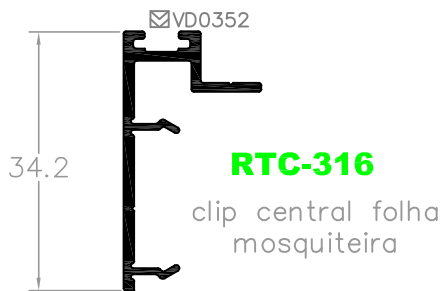

RTC-316

clip central folha
mosquiteira



RTC-317

clip central folha
mosquiteira

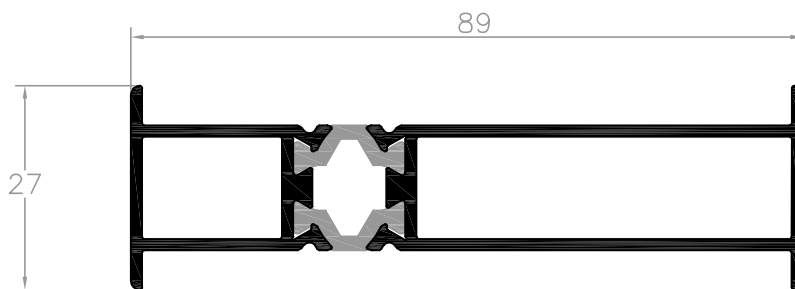

RTC-330

perfil ligação batente/correr